

Understanding and Specifying Amia 482 Series Work Chairs

Product Details

Amia 482 Series	126
Amia Upholstery	130
Dimensions	132

Specifying

Work Chairs

Sewn Leather Upholstery on Seat, Back, and Arm Caps	134
Upholstery on Seat and Back	136
3D Knit on Back with Upholstery on Seat	140
Air Back with 3D Microknit and Upholstery on Seat	142
Air Back with Upholstery on Seat	144

Stools

Upholstery on Seat and Back	146
3D Knit on Back with Upholstery on Seat	150
Air Back with 3D Microknit and Upholstery on Seat	152
Air Back with Upholstery on Seat	154

Work Chairs

Highly adjustable task seating offers maximum personalization for fit and comfort for a range of duration and use. By making a series of simple adjustments, you can customize the chair to your body, preferences, and tasks. These chairs provide continuous, stable, comfort, and can be quickly adjusted to support you in upright, and reclining work postures.

- Gesture 442 Series
- Leap 462 Series
- Think 465 Series
- Amia 482 Series
- Reply 466 Series
- Jersey Series
- Leap 464 Series WorkLounge
- Criterion 453 Series

Adjustability Features

► See page 24 for a comparison to other chairs.

Amia 482 Series

Mechanisms

Syncrotilt ●

Seat Adjustments

Pneumatic height ●

Passive seat edge angle ●

Seat depth ●

Back Adjustments

Lumbar height ●

Back tension ●

Back lock ●

Arm Adjustments

Arm height ●

Arm width ●

Arm pivot ●

Arm depth ●

Other Features

Foot ring height (stool) ●

Amia 482 Series

Amia effortlessly combines timeless, sophisticated design with high-performing ergonomics at an attainable price point. Amia can be personalized with different back designs expressed through upholstery, 3D Microknit, and plastic Air Back design combinations.

Outer back and outer seat are plastic. Fully upholstered outer back is available.

LiveLumbar system offers a dialed in spring force in the lumbar region that actively supports the lower back.

Arm height can adjust independently within a 4" range to help relieve upper back and shoulder fatigue.

Seat depth adjusts within a 3" range.

Five-arm base is standard.

Casters have hard, dual-wheels that roll smoothly on carpets. They are 2½" for increased mobility. Soft, dark grey treaded, dual-wheel roll-control casters are available for use on hard floors or mats. Stools are standard with 2" hard casters. Soft casters are available as an option.

Tip: Do not roll the chair across asphalt during installation as this may damage the casters.

Air LiveBack technology works through an innovative, geometric plastic design that flexes in two dimensions as the user moves to create a responsive, personalized comfort and fit.

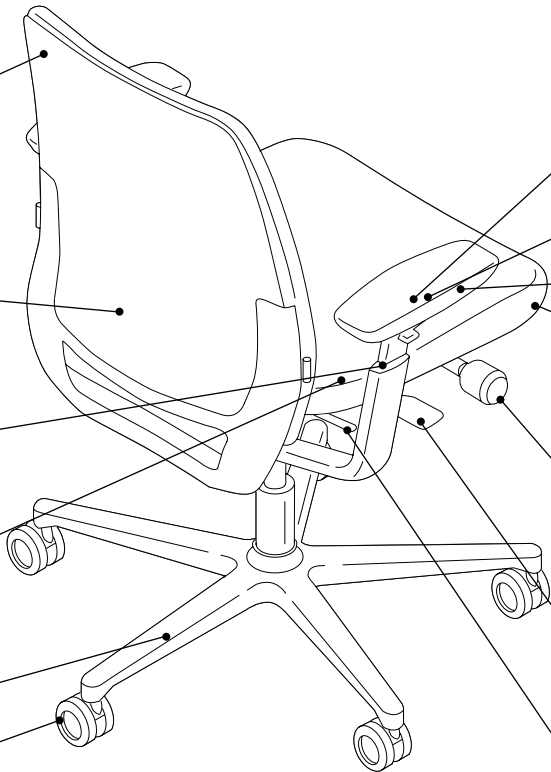

Arm depth can be adjusted approximately 3", enabling individuals to get closer to their work.

Arm width can adjust 4½" overall to provide forearm support.

Arm caps can pivot 30° in and out to accommodate individual user preferences.

Passive seat edge angle allows the front edge of the seat to flex 1½", relieving pressure behind the thighs.

Back tension accommodates a broader range of users by allowing user to change the rate of increase, or decrease, in force as the user reclines.

Seat height adjusts within a 5" range with a pneumatic adjustment mechanism. Stools have an 8" range.

Upright back lock allows the user to lock the back in a full upright position, or release it for full-tilt motion.

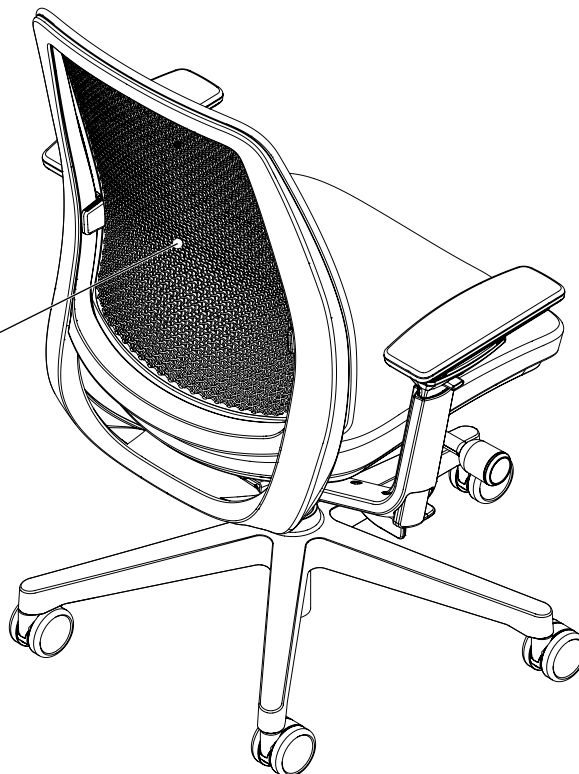

Product Details

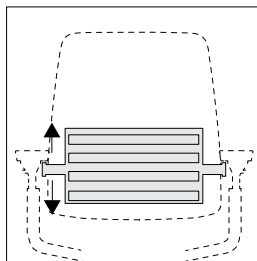

LiveLumbar system allows the user to experience continuous back support with dialed in spring force that can be adjusted to match the users anatomy. Available on standard Amia chairs.

Integrated LiveBack automatically creates flexibility and movement in the backrest to ensure dynamic back support as you recline. A height adjustable lumbar is also available on the Amia Air with 3D Microknit.

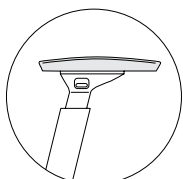

Rectilinear arms with soft caps are standard.

Models are standard with adjustable seats that include seat depth and passive seat edge angle.

Adjustability instructions are included with every chair. Instructions can also be found at www.steelcase.com

Cartoned request on your dealer purchase order means Amia chairs will ship knocked down with the chair back separated from the rest of the chair. This allows for shipment in a smaller carton. Assembly by a qualified dealer installer is required. Assembly instructions are included. This does not apply to Amia stools.

Uncartoned request on your dealer purchase order means Amia chairs will ship fully assembled.

Adjustment Features

Seat Adjustments

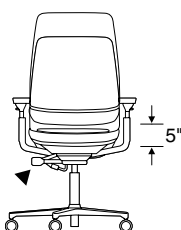

Seat height adjusts pneumatically. To lower, hold handle up while seated. To raise, hold handle up and keep your weight off the chair. Range of adjustability is 5", from 16"H to 21"H, and is standard on work chairs. A lower range of adjustability (15"H to 19"H) is available as an option. A higher range of adjustability (17"H to 24"H) is available as an option. An 8" range of adjustability (23"H to 31"H) is available on stools.

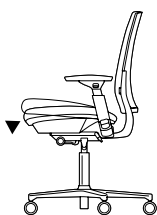

Passive seat edge angle flexes, relieving pressure under the user's thighs. The front flexes 1 1/2". This feature is standard on all work chairs and stools.

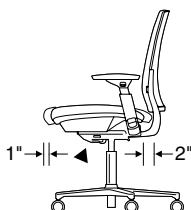

Seat depth adjusts 3" (15 1/2"-18 1/2") by pulling handle up. Slide seat forward or back to accommodate various leg lengths. Release handle to lock. This feature is standard on work chairs and stools.

Back Adjustments

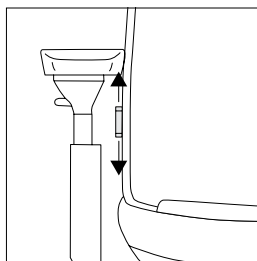

Lumbar height adjusts 3 3/4" (6 1/4" to 10" from seat) by grabbing exposed tabs and sliding the lumbar support up or down. This feature is standard on work chairs and stools.

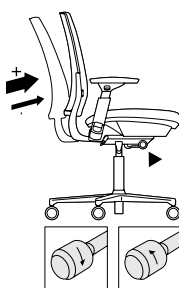

Back tension adjusts by turning knob forward to increase back tension, backward to decrease back tension. This feature is standard on work chairs and stools.

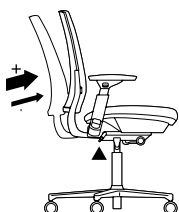

Upright back lock. To release, lean forward and pull toward back. To lock, lean forward and push toward front.

Arm Adjustments

Rectilinear height-, width-, pivot-, and depth-adjustable arms come standard on all arm models of chairs and stools.

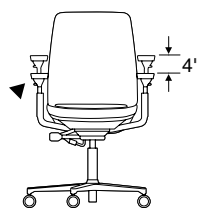

Arm height adjusts independently within a range of 4" (7"-11" from the seat). Push button on outside and under arm cap in while moving arms up or down. Releasing buttons locks arms in position.

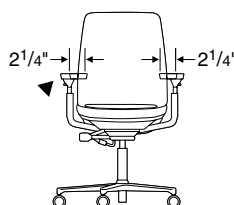

Arm width adjusts 2 1/4" each independently on chairs with this option. Grasp arm and move in or out.

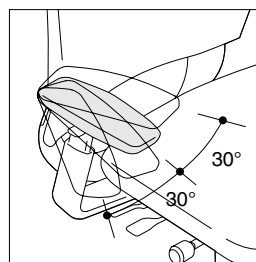

Arms pivot independently 30° inward and outward. Grasp arm and push front to left or right.

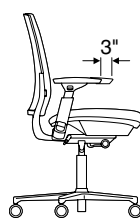

Arm depth adjusts approximately 3" to enable user to get closer to worksurface.

Other Features

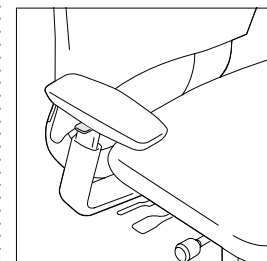

Height-only adjustable arm is also available and adjusts 4".



Armless models are also available.

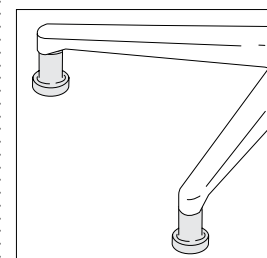

Glides are available as an option. Glides ship with chair or stool for field installation and maintain same height as casters.

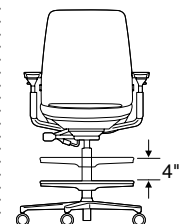

Foot ring height on stools adjusts by first lifting ring and rotating it counter-clockwise to unlock. Then raise or lower ring up to 4" to desired position before rotating it clockwise to lock. The foot ring has a diameter of 20".

Soft-wheel casters for hard floors are available for specific applications.

Surface Materials

▶ See surface materials on page 676 for specific availability or refer to the *Surface Materials Reference Manual* for further information.

Upholstery

- Fabric
- Fabric with soil-retardant treatment (option)
- 3D Knit (back only)
- 3D Microknit (Amia back only)
- Leather
- Elmosoft leather
- Select Surfaces leather
- Vinyl
- Customer's Own Leather (COL)
- Select Customer's Own Material/Vinyl (COM)

Hard components

- Back frame, outer back, arm retainer, and base
- 4799 Platinum Metallic
 - 6205 Black
 - 7243 Seagull
 - 7250 Sterling Dark

- Outer back, shell, inner back frame, and outer seat shell
- 6527 Merle

- Back shell and seat shell only
- 6249 Platinum

Outer back

- Fully upholstered

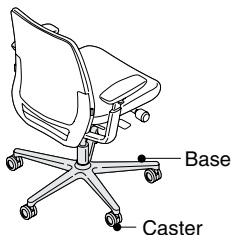

Polished aluminum base and casters

are available on chairs only. Polished aluminum casters approved to 225 pounds only. Stools are not available with this base.

Arm caps

- Black
- Leather

Column and foot ring on stools

- 7207 Black only

All Steelcase seating with standard upholstery fabrics complies with requirements of the State of California Technical Bulletin 117-2013. All standard seating is labeled to be in compliance with California 117-2013.

Programs & Services

▶ See the *Surface Materials Reference Manual* for further detail about programs and services offered for seating.

The Customer's Own Material (COM) Program

offers the opportunity for customers to select fabrics that are not offered through the standard Steelcase surface materials program for use on Steelcase products. Through the COM program, Steelcase will test your materials for application on Steelcase products. Once approved, you can place your order. Steelcase will facilitate the entire ordering process and give you a production schedule. Steelcase will order the COM fabric directly from the textile manufacturer. For up-to-date information regarding fabric test results for all COM fabrics and details regarding yardage requirements for most Seating lines, visit the COM website. To locate the COM website:

- Visit www.steelcase.com

Soil retardants are treatments that provide long-term soil and stain resistance to a fabric without affecting the shade or the integrity of the fabric. The following Steelcase Textiles are available pre-treated with soil retardant. (You do not need to select the soil-retardant option for these fabrics and incur the upcharge.)

- Jacks
- Link

For information on soil retardant fabrics on Select Surfaces, please refer to the *Surface Materials Reference Manual*.

Soil-retardant treatment is available on all other seating fabrics at an additional upcharge per seating unit. To order this option, please select "Soil-Retardant Treatment" under "Optional Accessories."

For soil-retardant treatment on COMs, please select "Soil-Retardant Treatment" under "Optional Accessories." Minimums or additional yardage may be required. Please contact the vendor directly for specific information.

Soil-retardant treatment is available on all other seating fabrics at an additional upcharge per seating unit. To order this option, please select "Soil-Retardant Treatment" under "Optional Accessories."

For soil-retardant treatment on COMs, please select "Soil-Retardant Treatment" under "Optional Accessories." Minimums or additional yardage may be required. Please contact the vendor directly for specific information.

Extended lead times may be necessary for this service.

Contact your Steelcase Solutions Fulfillment Team Representative at 1.888.STEELCASE (1.888.783.3522) or send an email to lineone@steelcase.com.

Fire Codes

▶ See page 696 for upholstery fabrics available for use with FCS modification.

Steelcase offers Fire Code Seating modification (FCS) on some seating models.

The most rigorous fire codes in the nation have been developed in California, and the Steelcase FCS modification is designed to meet those codes. Fire Code Seating (FCS) indicates that a product is constructed to meet the strict fire code requirements of high public occupancy areas such as theaters, meeting rooms, and lobbies. The FCS standards will meet the State of California Bureau of Electronic and Appliance Repair, Home Furnishings, and Thermal Insulation Technical Bulletin 133 (Cal TB 133). Boston adopted the California Bureau of Electronic and Appliance Repair, Home Furnishings, and Thermal Insulation Technical Bulletin TB 133 test standard in 1992.

Local codes may have special requirements for upholstery.

Dimensions

▶ Page 132

Resources

Printed Materials

- ▶ Amia Brochure (11-0002073)
- ▶ Amia User Guide (07-0006468)
- ▶ Amia LiveLumbar card (08-0000111)
- ▶ Innovation Seating Brochure (04-0011870)
- ▶ Alive Seating Story
- ▶ Amia Air Cut Sheet (18-0005529)

Online Resources

- ▶ Interactive User Guide available on www.steelcase.com
- ▶ Amia Model Sales Presentation DVD
- ▶ Amia Design Story video available on www.steelcase.com
- ▶ Adjustability video available on www.steelcase.com
- ▶ Environmental profiles available on www.steelcase.com/sustainability.

Color Scheme Matrix

Amia Color Scheme	Outer Back Shell	Outer Back Frame	Arm Holsters	Outer Seat Shell	Base
Black	Black plastic-6205	Black plastic-6205	Black plastic-6205	Black plastic-6205	Black plastic-6205
Merle	Merle plastic-6527	Sterling Dark paint-7250	Sterling Dark paint-7250	Merle plastic-6527	Sterling Dark paint-7250
Platinum	Platinum plastic-6249	Platinum Metallic paint-4799	Platinum Metallic paint-4799	Platinum plastic-6249	Platinum Metallic paint-4799
Seagull	Platinum plastic-6249	Seagull paint-7243	Seagull paint-7243	Platinum plastic-6249	Seagull paint-7243

Amia Air Color Scheme	Inner Back Frame and Lumbar	Outer Back Frame	Arm Holsters	Outer Seat Shell	Base
Black	Black plastic-6205	Black plastic-6205	Black plastic-6205	Black plastic-6205	Black plastic-6205
Merle	Merle plastic-6527	Sterling Dark paint-7250	Sterling Dark paint-7250	Merle plastic-6527	Sterling Dark paint-7250
Platinum	Merle plastic-6527	Platinum Metallic paint-4799	Platinum Metallic paint-4799	Merle plastic-6527	Platinum Metallic paint-4799
Seagull	Merle plastic-6527	Seagull paint-7243	Seagull paint-7243	Merle plastic-6527	Seagull paint-7243

Amia Upholstery

What Is It?

Fabric, leather, or vinyl-covered back and seat, 3D Knit back

Fabric

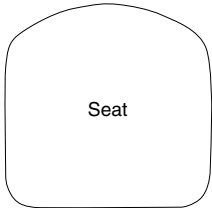

Leather, Vinyl, and Select Fabrics

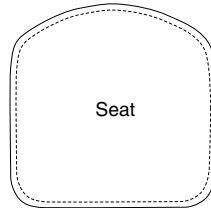
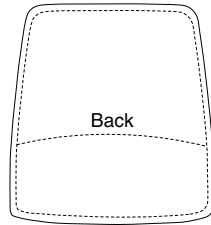

3D Knit and 3D Microknit Back

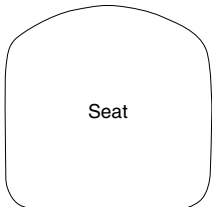
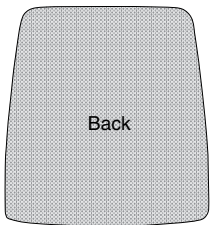

Stitched seams are included on the back cushion and seat cushion of the following:

- Leather
- Elmosoft leather
- Select Surfaces leather
- Customer's Own Leather (COL)
- Vinyl
- Select Customer's Own Material/Vinyl (COM)
- Select Fabrics

Pattern alignment at the lumbar seam cannot be guaranteed.

3D Knit back is made up of three layers: the 3D Knit, a solid fabric that matches the 3D Knit color, and the polyester cushion that provides exceptional comfort. The seat on these models can be specified to match the 3D Knit color or in any other material.

3D Microknit back upholstery is applied directly over plastic air back. A Cogent: Connect fabric can be specified on the seat to color match the 3D Microknit, except seagull. The 3D Microknit can be specified to match or contrast the air back.

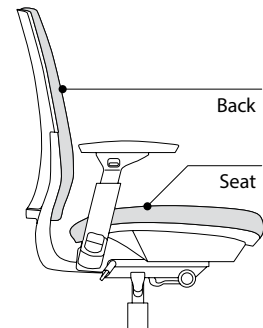
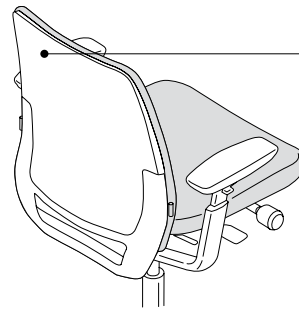
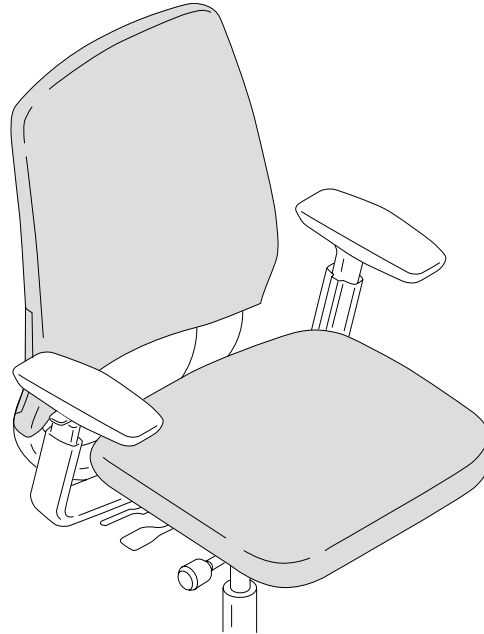

Plastic outer back is fully exposed. Fully upholstered outer back is available.

Seat and back cushions can be removed and replaced if damaged.

Dimensions

Amia 482 Series

Features	Overall Depth	Width	Height	Seat Depth	Functional Seat Depth	Seat Width	Seat Height from Floor	Ring Height from Floor	Back Width
----------	---------------	-------	--------	------------	-----------------------	------------	------------------------	------------------------	------------

Amia 482 Series

Work Chairs

Adjustable Seat Depth	21 ³ / ₄ " to 24 ³ / ₄ "	26 ⁵ / ₈ "	37 ¹ / ₄ " to 42 ¹ / ₂ "	18 ¹ / ₂ "	15 ¹ / ₂ " to 18 ¹ / ₂ "	19 ³ / ₈ "	16" to 21"	N.A.	18 ⁷ / ₈ "
-----------------------	--	----------------------------------	--	----------------------------------	--	----------------------------------	------------	------	----------------------------------

Stools

Adjustable Seat Depth	21 ³ / ₄ " to 24 ³ / ₄ "	26 ⁵ / ₈ "	44 ¹ / ₄ " to 52 ¹ / ₂ "	18 ¹ / ₂ "	15 ¹ / ₂ " to 18 ¹ / ₂ "	19 ³ / ₈ "	23" to 31"	10 ¹ / ₄ " to 14 ¹ / ₄ "	18 ⁷ / ₈ "
-----------------------	--	----------------------------------	--	----------------------------------	--	----------------------------------	------------	--	----------------------------------

Dimensions were measured with BIFMA CMD (chair-measuring device).

Arm width adjustment

is 15"–19¹/₂". Arm pivot adjustment adds 2³/₄" to the width providing a total of 12¹/₄"–20¹/₂" of width between the arms.

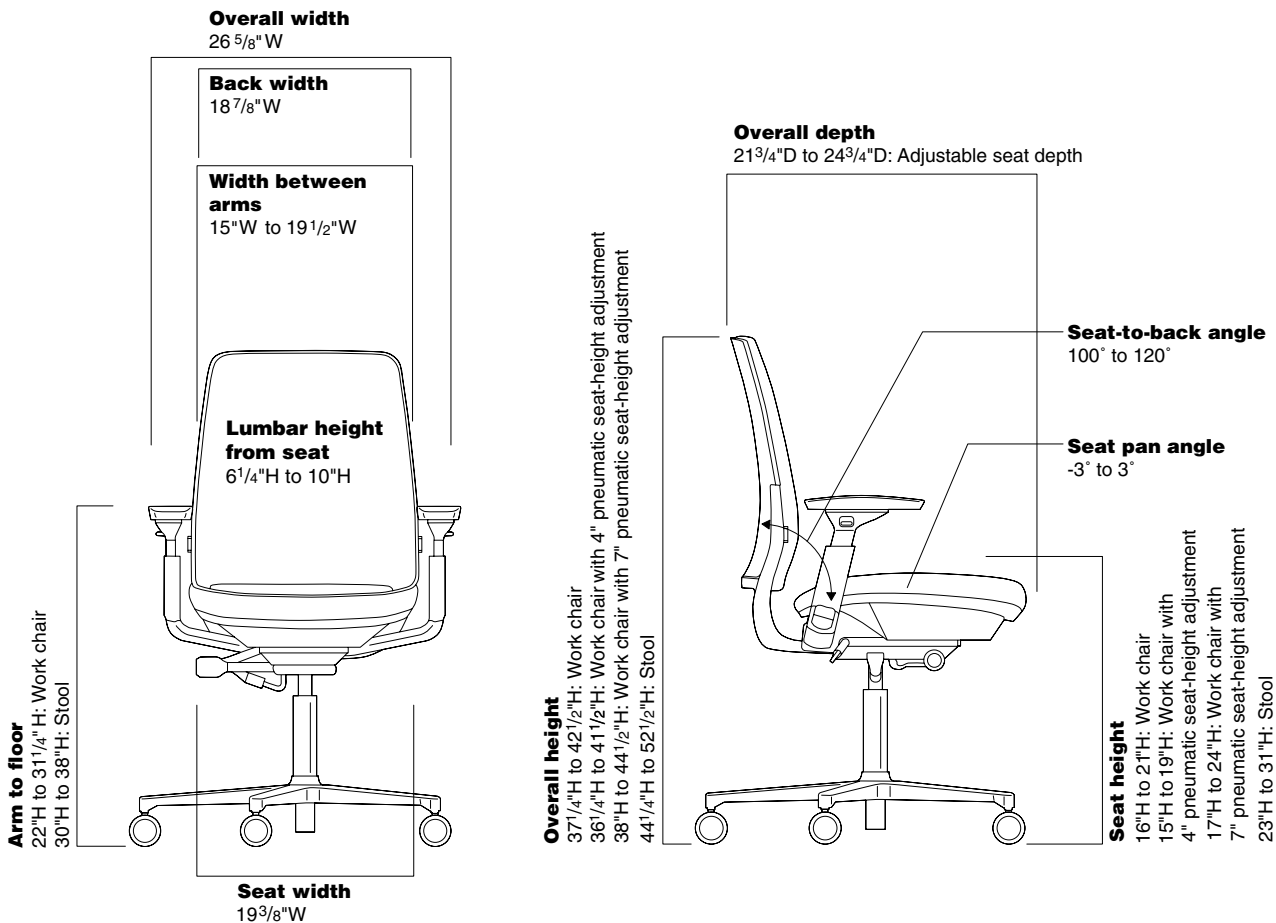

• Back Height from Seat	• Back Lumbar Height	• Lumbar Flex Zone	• Width Between Arms	• Arm to Floor	• Arm Height from Seat	• Arm Cap Pivot Range	• Seat Pan Angle	• Angle Between Seat and Back
-------------------------	----------------------	--------------------	----------------------	----------------	------------------------	-----------------------	------------------	-------------------------------

25"	6¼" to 10"	5¼" to 10¼"	15" to 19½"	22" to 32¼"	7" to 11"	30°	-3° to 3°	100° to 120°
-----	------------	-------------	-------------	-------------	-----------	-----	-----------	--------------

25"	6¼" to 10"	5¼" to 10¼"	15" to 19½"	22" to 32¼"	7" to 11"	30°	-3° to 3°	100° to 120°
-----	------------	-------------	-------------	-------------	-----------	-----	-----------	--------------

:	:	:	:	:	:	:	:	:
---	---	---	---	---	---	---	---	---

Amia 482 Series Work Chair

Sewn Leather Upholstery on Seat, Back, and Arm Caps



Standard Includes		Required to Specify
<ul style="list-style-type: none"> ▶ Need help? Product details, page 126 	<ul style="list-style-type: none"> • Synchro-tilt mechanism • 5" pneumatic seat-height adjustment • Upright back lock • Rectilinear independent height-, width-, pivot-, and depth-adjustable arms • Frame and arms: platinum • 3" seat depth adjustment • Five-arm base: polished aluminum • Passive seat edge angle • Adjustable lumbar • Fully upholstered outer back, seat, and arm caps: leather • Sewn upholstery design • 2½"-diameter, hard-composition, dual-wheel casters: polished aluminum 	<ol style="list-style-type: none"> 1 Style number 2 Leather color number for upholstery on back, seat, and arm caps 3 Options, if selected (see below) <ul style="list-style-type: none"> ▶ See <i>Surface Materials</i>, page 676.

Tip: Fire Code Seating (FCS) option is available with certain upholstery fabric choices only.

▶ Page 696

Tip: Fire Code Seating (FCS) option is available on Amia chairs with fully adjustable arms only.

Options	U.S. Price	Required to Specify
Surface Materials Upholstery <ul style="list-style-type: none"> • Elmosoft leather upholstery +\$ 91 • Select Surfaces leather price group 2 +\$ 91 • Customer's Own Leather (COL) No cost Soil-retardant treatment +\$ 28 Fire Code Seating (FCS) +\$ 87 Frame and arms <ul style="list-style-type: none"> • Black plastic -\$ 50 		Specify Elmosoft leather color number. ▶ See <i>Surface Materials Reference Manual</i> . Specify leather color number. Specify with soil-retardant treatment. Add suffix F to the style number. Specify with 6205 Black.
Base <ul style="list-style-type: none"> • Plastic base -\$233 		Specify with plastic base.
Arms <ul style="list-style-type: none"> • Height-adjustable arms, soft arm caps -\$100 		Specify with height-adjustable arms.
Seat Height <ul style="list-style-type: none"> • 4" pneumatic seat-height adjustment +\$ 65 • 7" pneumatic seat-height adjustment +\$ 65 		Specify with 4" pneumatic seat-height adjustment. Specify with 7" pneumatic seat-height adjustment.
Casters Polished aluminum base <ul style="list-style-type: none"> • Soft, dual-wheel casters for use on hard floors: polished aluminum +\$ 28 • Hard, dual-wheel casters for use on soft floors: plastic -\$ 66 • Soft, dark grey treaded, dual-wheel roll-control casters for use on hard floors: plastic -\$ 40 Plastic base <ul style="list-style-type: none"> • Soft, dark grey treaded, dual-wheel roll-control casters for use on hard floors: plastic +\$ 28 		Specify with soft polished aluminum casters. Specify with hard plastic casters. Specify with soft plastic casters. Specify with soft roll-control casters.
Glides Polished aluminum base <ul style="list-style-type: none"> • Glides: plastic -\$ 40 Plastic base <ul style="list-style-type: none"> • Glides: plastic +\$ 28 		Specify with glides. Specify with glides.

Tip: Plastic base available with plastic casters only.

Tip: Polished aluminum casters are available on a polished aluminum base only.

▶ Detailed dimensions, page 132

 **For Canadian Pricing**
Multiply U.S. Price by the Canadian price factor.

▶ See page 1 for details.

Specification Information	
Style Number	U.S. Base Price
4821410LS	\$2409

Amia 482 Series Work Chair

Upholstery on Seat and Back



Tip: Frame packages include outer back shell, outer back frame, arm holsters, outer seat shell, and base.

Tip: When merle, platinum, or seagull are selected as frame packages, the outer seat shell and inner back frame default to 6527 Merle plastic.

*Tip: Suffixes other than **K** for contrasting fabric, will be added in alphabetical order when specifying options. The contrasting fabric suffix, **K**, will always be at the end of the style number.*

Tip: Leather and vinyl upcharges are in addition to sewn upholstery upcharge.

Standard Includes	Required to Specify
-------------------	---------------------

<ul style="list-style-type: none"> ▶ Need help? Product details, page 126 	<ul style="list-style-type: none"> • Frame package color scheme: black • Synchro-tilt mechanism • 5" pneumatic seat-height adjustment • Upright back lock • Rectilinear independent height-, width-, pivot-, and depth-adjustable arms and soft arm caps: black plastic • 3" seat depth adjustment • Passive seat edge angle • Adjustable lumbar • Standard upholstery design: fabric price group 1 • 2½"-diameter, hard-composition, dual-wheel casters: black 	<ol style="list-style-type: none"> 1 Style number 2 Frame package color scheme (see below under Required Selections) 3 Fabric color number for upholstery on seat and back 4 Options, if selected (see below) <p>▶ See <i>Surface Materials</i>, page 676.</p>
--	---	--

Frame Package Color Scheme	Required Selections	U.S. Price	Required to Specify
----------------------------	---------------------	------------	---------------------

<ul style="list-style-type: none"> • Black • Merle • Platinum • Seagull 	<ul style="list-style-type: none"> No cost +\$ 50 +\$ 50 +\$ 50 	<ul style="list-style-type: none"> Specify with 6205 Black. Specify with 6527 Merle. Specify with 6249 Platinum. Specify with 6053 Seagull.
---	---	---

Surface Materials	Options	U.S. Price	Required to Specify
-------------------	---------	------------	---------------------

<ul style="list-style-type: none"> • Fabric price group 1 • Fabric price group 2 • Fabric price group 3 • Fabric price group 4 • Fabric price group 5 • Fabric price group 6 • Fabric price group 7 • Fabric price group 8 • Fabric price group 9 • Fabric price group 10 • Steelcase leather upholstery 	<p>Upholstery on seat and back</p> <ul style="list-style-type: none"> • Select Surfaces leather price group 1 • Elmosoft leather upholstery • Select Surfaces leather price group 2 • Steelcase vinyl 	<ul style="list-style-type: none"> No cost +\$ 29 +\$ 53 +\$ 75 +\$ 95 +\$116 +\$135 +\$169 +\$208 +\$235 +\$312 +\$312 +\$372 +\$372 +\$ 29 	<ul style="list-style-type: none"> Specify fabric color number. Specify fabric color number. Specify fabric color number. Specify fabric color number. Specify fabric color number. Specify fabric color number. Specify fabric color number. Specify fabric color number. Specify fabric color number. Specify fabric color number. Add suffix S to the style number and specify leather color number. Add suffix S to the style number and specify Select Surfaces leather price group 1. ▶ See <i>Surface Materials Reference Manual</i>. Add suffix S to the style number and specify Elmosoft leather color number. Add suffix S to the style number and specify Select Surfaces leather price group 2. ▶ See <i>Surface Materials Reference Manual</i>. Add suffix S to the style number and specify vinyl color number.
<p>Contrasting upholstery on seat and back</p>			
<ul style="list-style-type: none"> • Contrasting fabrics 		<ul style="list-style-type: none"> +\$ 34 	<ul style="list-style-type: none"> Add suffix K to the style number and specify fabric color numbers.
<p>Sewn upholstery</p>			
<ul style="list-style-type: none"> • Sewn upholstery on chair 		<ul style="list-style-type: none"> +\$ 87 	<ul style="list-style-type: none"> Add suffix S to the style number.

▶ Options, continued on next page

▶ Detailed dimensions, page 132



For Canadian Pricing

Multiply U.S. Price by the Canadian price factor.

▶ See page 1 for details.

► Options, continued from previous page

	Options	U.S. Price	Required to Specify
Surface Materials, continued	Contrasting upholstery on seat		
	• Fabric price group 1	No cost	Specify fabric color number.
	• Fabric price group 2	+\$ 15	Specify fabric color number.
	• Fabric price group 3	+\$ 26	Specify fabric color number.
	• Fabric price group 4	+\$ 36	Specify fabric color number.
	• Fabric price group 5	+\$ 48	Specify fabric color number.
	• Fabric price group 6	+\$ 58	Specify fabric color number.
	• Fabric price group 7	+\$ 68	Specify fabric color number.
	• Fabric price group 8	+\$ 84	Specify fabric color number.
	• Fabric price group 9	+\$104	Specify fabric color number.
	• Fabric price group 10	+\$116	Specify fabric color number.
	• Steelcase leather upholstery	+\$156	Add suffix S to the style number and specify leather color number.
	• Select Surfaces leather price group 1	+\$156	Add suffix S to the style number and specify leather color number.
	• Elmosoft leather upholstery	+\$186	Add suffix S to the style number and specify leather color number.
	• Select Surfaces leather price group 2	+\$186	Add suffix S to the style number and specify leather color number.
	• Customer's Own Material (COM)	No cost	► See <i>Surface Materials Reference Manual</i>
		Contrasting upholstery on back	
• Fabric price group 1	No cost	Specify fabric color number.	
• Fabric price group 2	+\$ 15	Specify fabric color number.	
• Fabric price group 3	+\$ 26	Specify fabric color number.	
• Fabric price group 4	+\$ 37	Specify fabric color number.	
• Fabric price group 5	+\$ 48	Specify fabric color number.	
• Fabric price group 6	+\$ 59	Specify fabric color number.	
• Fabric price group 7	+\$ 68	Specify fabric color number.	
• Fabric price group 8	+\$ 85	Specify fabric color number.	
• Fabric price group 9	+\$104	Specify fabric color number.	
• Fabric price group 10	+\$117	Specify fabric color number.	
• Steelcase leather upholstery	+\$149	Add suffix S to the style number and specify leather color number.	
• Select Surfaces leather price group 1	+\$157	Add suffix S to the style number and specify leather color number.	
• Elmosoft leather upholstery	+\$186	Add suffix S to the style number and specify leather color number.	
• Select Surfaces leather price group 2	+\$186	Add suffix S to the style number and specify leather color number.	
• Customer's Own Material (COM)	No cost	► See <i>Surface Materials Reference Manual</i>	
	Soil-retardant treatment	+\$ 28	Specify <i>with soil-retardant treatment</i> .
	Fire Code Seating (FCS)	+\$ 87	Add suffix F to the style number.
	Fully upholstered		
• Fully upholstered with fabric	+\$146	Add suffix U to the style number.	
• Fully upholstered with leather	+\$233	Add suffix SU to the style number.	
• Steelcase leather fully upholstered outer back	+\$511	Add suffix SU to the style number and specify leather color number.	
• Select Surfaces leather price group 1 fully upholstered outer back	+\$511	Add suffix SU to the style number and specify Select Surfaces leather price group 1.	
		► See <i>Surface Materials Reference Manual</i>	
• Elmosoft leather fully upholstered outer back	+\$601	Add suffix SU to the style number and specify Elmosoft leather color number.	
• Select Surfaces leather price group 2 fully upholstered outer back	+\$601	Add suffix SU to the style number and specify Select Surfaces leather price group 2.	
		► See <i>Surface Materials Reference Manual</i>	
• Customer's Own Leather (COL) fully upholstered outer back	No cost	Add suffix SU to the style number.	
		► See <i>Surface Materials Reference Manual</i> to specify.	

Tip: Suffixes other than **K** for contrasting fabric, will be added in alphabetical order when specifying options. The contrasting fabric suffix, **K**, will always be at the end of the style number.

Tip: Leather and vinyl upcharges are in addition to sewn upholstery upcharge.

Tip: To get leather on a fully upholstered chair, you will need to add both the fully upholstered with leather upcharge and the upcharge for the leather itself.

► Options, continued on next page

For Canadian Pricing
Multiply U.S. Price by the Canadian price factor.
► See page 1 for details.

Amia 482 Series Work Chair, Upholstery on Seat and Back, continued

► Options, continued from previous page

Options	U.S. Price	Required to Specify
Base	• Polished aluminum base +\$167	Specify with polished aluminum base.
Arms	• Height-adjustable arms, soft arm caps -\$100	Specify with height-adjustable arms.
	• Armless -\$232	Specify without arms.
Seat Height	• 4" pneumatic seat-height adjustment +\$ 65	Specify with 4" pneumatic seat-height adjustment.
	• 7" pneumatic seat-height adjustment +\$ 65	Specify with 7" pneumatic seat-height adjustment.
Casters	• Soft, dark grey treaded, dual-wheel roll-control casters for use on hard floors +\$ 28	Specify with soft roll-control casters.
	• Hard, polished aluminum casters on polished aluminum base for use on soft floors +\$ 66	Specify with hard polished aluminum casters.
	• Soft, polished aluminum casters on polished aluminum base for use on hard floors +\$ 93	Specify with soft polished aluminum casters.
Glides	• Glides: plastic +\$ 28	Specify with glides.

Specification Information

Style Number	U.S. Base Price
4821410	\$1181



For Canadian Pricing

Multiply U.S. Price by the Canadian price factor.

► See page 1 for details.

Amia 482 Series Work Chair

3D Knit on Back with Upholstery on Seat



Standard Includes		Required to Specify
<ul style="list-style-type: none"> ▶ Need help? Product details, page 126 	<ul style="list-style-type: none"> • Frame package color scheme: black • Synchro-tilt mechanism • 5" pneumatic seat-height adjustment • Upright back lock • Rectilinear independent height-, width-, pivot-, and depth-adjustable arms and soft arm caps: black plastic • 3" seat depth adjustment • Passive seat edge angle • Height-adjustable lumbar • 3D Knit on back only • Standard upholstery design on seat: fabric price group 1 • 2½"-diameter, hard-composition, dual-wheel casters: black 	<ol style="list-style-type: none"> 1 Style number 2 Frame package color scheme (see below under Required Selections) 3 3D Knit color for back 4 Fabric color number for upholstery on seat 5 Options, if selected (see below) <ul style="list-style-type: none"> ▶ See <i>Surface Materials</i>, page 676.

Tip: Frame packages include outer back shell, outer back frame, arm holsters, outer seat shell, and base.

Required Selections	U.S. Price	Required to Specify
Frame Package Color Scheme <ul style="list-style-type: none"> • Black • Merle • Platinum • Seagull 	<ul style="list-style-type: none"> No cost +\$ 50 +\$ 50 +\$ 50 	<ul style="list-style-type: none"> Specify with 6205 Black. Specify with 6527 Merle. Specify with 6249 Platinum. Specify with 6053 Seagull.

Options	U.S. Price	Required to Specify
Surface Materials <ul style="list-style-type: none"> • Upholstery <ul style="list-style-type: none"> • Fabric price group 1 • Fabric price group 2 • Fabric price group 3 • Fabric price group 4 • Fabric price group 5 • Fabric price group 6 • Fabric price group 7 • Fabric price group 8 • Fabric price group 9 • Fabric price group 10 • Steelcase leather upholstery • Select Surfaces leather price group 1 • Elmosoft leather upholstery • Select Surfaces leather price group 2 • Steelcase vinyl • Customer's Own Material (COM) • Customer's Own Leather (COL) 	<ul style="list-style-type: none"> No cost +\$ 15 +\$ 26 +\$ 36 +\$ 48 +\$ 58 +\$ 68 +\$ 84 +\$104 +\$116 +\$156 +\$156 +\$186 +\$186 +\$ 15 No cost No cost 	<ul style="list-style-type: none"> Specify fabric color number. Specify fabric color number. Specify fabric color number. Specify fabric color number. Specify fabric color number. Specify fabric color number. Specify fabric color number. Specify fabric color number. Specify fabric color number. Specify fabric color number. Add suffix S to the style number and specify leather color number. Add suffix S to the style number and specify Select Surfaces leather price group 1. ▶ See <i>Surface Materials Reference Manual</i>. Add suffix S to the style number and specify Elmosoft leather color number. Add suffix S to the style number and specify Select Surfaces leather price group 2. ▶ See <i>Surface Materials Reference Manual</i>. Add suffix S to the style number and specify vinyl color number. ▶ See <i>Surface Materials Reference Manual</i> to specify. Add suffix S to the style number and specify leather color number.
Soil-retardant treatment	+\$ 28	Specify with soil-retardant treatment.
Fire Code Seating (FCS)	+\$ 87	Add suffix F to the style number.
Sewn upholstery <ul style="list-style-type: none"> • Sewn upholstery on chair 	+\$ 45	Add suffix S to the style number.
Base <ul style="list-style-type: none"> • Polished aluminum base 	+\$167	Specify with polished aluminum base.

Tip: Always add suffixes in alphabetical order when specifying options to Amia seating.

Tip: Leather and vinyl upcharges are in addition to sewn upholstery upcharge.

Tip: Fire Code Seating (FCS) option is available with certain upholstery fabric choices only.
▶ Page 696

Tip: Fire Code Seating (FCS) option is available on Amia chairs with fully adjustable arms or armless models only.

▶ Detailed dimensions, page 132

▶ Options, continued on next page

► Options, continued from previous page

	Options	U.S. Price	Required to Specify
Arms	• Height-adjustable arms, soft arm caps	-\$100	Specify <i>with height-adjustable arms</i> .
	• Armless	-\$232	Specify <i>without arms</i> .
Seat Height	• 4" pneumatic seat-height adjustment	+\$ 65	Specify <i>with 4" pneumatic seat-height adjustment</i> .
	• 7" pneumatic seat-height adjustment	+\$ 65	Specify <i>with 7" pneumatic seat-height adjustment</i> .
Casters	• Soft, dark grey treaded, dual-wheel roll-control casters for use on hard floors	+\$ 28	Specify <i>with soft roll-control casters</i> .
	• Hard, polished aluminum casters on polished aluminum base for use on soft floors	+\$ 66	Specify <i>with hard polished aluminum casters</i> .
	• Soft, polished aluminum casters on polished aluminum base for use on hard floors	+\$ 93	Specify <i>with soft polished aluminum casters</i> .
Glides	• Glides: plastic	+\$ 28	Specify <i>with glides</i> .

Specification Information

Style Number	U.S. Base Price
4821418	\$1247

**For Canadian Pricing**

Multiply U.S. Price by the Canadian price factor.

► See page 1 for details.

Amia 482 Series Work Chair

Air Back with 3D Microknit and Upholstery on Seat



Tip: Amia Air frame packages include inner back frame and lumbar, outer back frame, arm holsters, outer seat shell, and base.

Tip: When merle, platinum, or seagull are selected as frame packages, the outer seat shell and inner back frame default to 6527 Merle plastic.

Tip: Leather and vinyl upcharges are in addition to sewn upholstery upcharge.

Tip: To specify a non-contrasting seat back, the air back plastic color finish and 3D Microknit color finish must be the same.

► Detailed dimensions, page 132



For Canadian Pricing

Multiply U.S. Price by the Canadian price factor.

► See page 1 for details.

Standard Includes		Required to Specify
► Need help? Product details, page 126	<ul style="list-style-type: none"> • Frame package color scheme: black • Synchro-tilt mechanism • 5" pneumatic seat-height adjustment • Upright back lock • Rectilinear independent height-, width-, pivot-, and depth-adjustable arms and soft arm caps: black plastic • 3" seat depth adjustment • Passive seat edge angle • Air back with integrated Air LiveBack technology: plastic price groups 1 and 2 • Height-adjustable lumbar • 3D Microknit on back only • Standard upholstery design on seat: fabric price group 1 • 2½"-diameter, hard-composition, dual-wheel casters: black 	<ol style="list-style-type: none"> 1 Style number 2 Frame package color scheme (see below under Required Selections) 3 Fabric color number for upholstery on seat 4 Air back plastic color number 5 3D Microknit color number for back 6 Options, if selected (see below) <p>► See <i>Surface Materials</i>, page 676.</p>

Required Selections	U.S. Price	Required to Specify
Frame Package Color Scheme	<ul style="list-style-type: none"> • Black No cost • Merle +\$ 50 • Platinum +\$ 50 • Seagull +\$ 50 	<p>Specify with 6205 Black.</p> <p>Specify with 6527 Merle.</p> <p>Specify with 6249 Platinum.</p> <p>Specify with 6053 Seagull.</p>

Options	U.S. Price	Required to Specify
Surface Materials		
Upholstery	<ul style="list-style-type: none"> • Fabric price group 1 No cost • Fabric price group 2 +\$ 15 • Fabric price group 3 +\$ 26 • Fabric price group 4 +\$ 36 • Fabric price group 5 +\$ 48 • Fabric price group 6 +\$ 58 • Fabric price group 7 +\$ 68 • Fabric price group 8 +\$ 84 • Fabric price group 9 +\$104 • Fabric price group 10 +\$116 • Steelcase leather upholstery +\$156 	<p>Specify fabric color number.</p> <p>Specify fabric color number.</p> <p>Specify fabric color number.</p> <p>Specify fabric color number.</p> <p>Specify fabric color number.</p> <p>Specify fabric color number.</p> <p>Specify fabric color number.</p> <p>Specify fabric color number.</p> <p>Specify fabric color number.</p> <p>Specify fabric color number.</p> <p>Specify fabric color number.</p> <p>Add suffix S to the style number and specify leather color number.</p> <p>Add suffix S to the style number and specify Select Surfaces leather price group 1.</p> <p>► See <i>Surface Materials Reference Manual</i>. Add suffix S to the style number and specify Elmosoft leather color number.</p> <p>Add suffix S to the style number and specify Select Surfaces leather price group 2.</p> <p>► See <i>Surface Materials Reference Manual</i>. Add suffix S to the style number and specify vinyl color number.</p> <p>► See <i>Surface Materials Reference Manual</i> to specify.</p> <p>Add suffix S to the style number and specify leather color number.</p>
• Select Surfaces leather price group 1	+\$156	
• Elmosoft leather upholstery	+\$186	
• Select Surfaces leather price group 2	+\$186	
• Steelcase vinyl	+\$ 14	
• Customer's Own Material (COM)	No cost	
• Customer's Own Leather (COL)	No cost	
Soil-retardant treatment	+\$ 28	Specify with soil-retardant treatment.
Sewn upholstery		
• Sewn upholstery on chair	+\$ 45	Add suffix S to the style number.
Base		
• Polished aluminum base	+\$167	Specify with polished aluminum base.
Arms		
• Height-adjustable arms, soft arm caps	-\$100	Specify with height-adjustable arms.
• Armless	-\$232	Specify without arms.

► Options, continued on next page

► Options, continued from previous page

	Options	U.S. Price	Required to Specify
Lumbar	• No lumbar	-\$28	Specify <i>with no lumbar</i> .
Seat Height	• 4" pneumatic seat-height adjustment	+\$65	Specify <i>with 4" pneumatic seat-height adjustment</i> .
	• 7" pneumatic seat-height adjustment	+\$65	Specify <i>with 7" pneumatic seat-height adjustment</i> .
Casters	• Soft, dark grey treaded, dual-wheel roll-control casters for use on hard floors	+\$28	Specify <i>with soft roll-control casters</i> .
	• Hard, polished aluminum casters on polished aluminum base for use on soft floors	+\$66	Specify <i>with hard polished aluminum casters</i> .
	• Soft, polished aluminum casters on polished aluminum base for use on hard floors	+\$93	Specify <i>with soft polished aluminum casters</i> .
Glides	• Glides: plastic	+\$28	Specify <i>with glides</i> .

Specification Information

Style Number	U.S. Base Price
4821414	\$1066

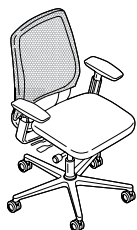

 **For Canadian Pricing**
Multiply U.S. Price by the Canadian price factor.
► See page 1 for details.

Amia 482 Series Work Chair

Air Back with Upholstery on Seat



Tip: Frame packages include outer back shell, outer back frame, arm holsters, outer seat shell, and base.

Tip: When merle, platinum, or seagull are selected as frame packages, the outer seat shell and inner back frame default to 6527 Merle plastic.

Tip: Leather and vinyl upcharges are in addition to sewn upholstery upcharge.

► Detailed dimensions, page 132



For Canadian Pricing
Multiply U.S. Price by the Canadian price factor.

► See page 1 for details.

Standard Includes		Required to Specify
► Need help? Product details, page 126	<ul style="list-style-type: none"> • Frame package color scheme: black • Synchro-tilt mechanism • 5" pneumatic seat-height adjustment • Upright back lock • Rectilinear independent height-, width-, pivot-, and depth-adjustable arms and soft arm caps: black plastic • 3" seat depth adjustment • Passive seat edge angle • Air back with integrated Air LiveBack technology: plastic price groups 1 and 2 • Standard upholstery design on seat: fabric price group 1 • 2½"-diameter, hard-composition, dual-wheel casters: black 	<ol style="list-style-type: none"> 1 Style number 2 Frame package color scheme (see below under Required Selections) 3 Fabric color number for upholstery on seat 4 Air back plastic color number 5 Options, if selected (see below) <p>► See <i>Surface Materials</i>, page 676.</p>

Required Selections	U.S. Price	Required to Specify
Frame Package Color Scheme	<ul style="list-style-type: none"> • Black No cost • Merle +\$ 50 • Platinum +\$ 50 • Seagull +\$ 50 	<ul style="list-style-type: none"> Specify with 6205 Black. Specify with 6527 Merle. Specify with 6249 Platinum. Specify with 6053 Seagull.

Options	U.S. Price	Required to Specify
Surface Materials		
Upholstery		
• Fabric price group 1	No cost	Specify fabric color number.
• Fabric price group 2	+\$ 15	Specify fabric color number.
• Fabric price group 3	+\$ 26	Specify fabric color number.
• Fabric price group 4	+\$ 36	Specify fabric color number.
• Fabric price group 5	+\$ 48	Specify fabric color number.
• Fabric price group 6	+\$ 58	Specify fabric color number.
• Fabric price group 7	+\$ 68	Specify fabric color number.
• Fabric price group 8	+\$ 84	Specify fabric color number.
• Fabric price group 9	+\$104	Specify fabric color number.
• Fabric price group 10	+\$116	Specify fabric color number.
• Steelcase leather upholstery	+\$156	Add suffix S to the style number and specify leather color number.
• Select Surfaces leather price group 1	+\$156	Add suffix S to the style number and specify Select Surfaces leather price group 1.
		► See <i>Surface Materials Reference Manual</i> . Add suffix S to the style number and specify Elmosoft leather color number.
• Elmosoft leather upholstery	+\$186	Add suffix S to the style number and specify Select Surfaces leather price group 2.
• Select Surfaces leather price group 2	+\$186	► See <i>Surface Materials Reference Manual</i> . Add suffix S to the style number and specify vinyl color number.
• Steelcase vinyl	+\$ 15	► See <i>Surface Materials Reference Manual</i> to specify.
• Customer's Own Material (COM)	No cost	Add suffix S to the style number and specify leather color number.
• Customer's Own Leather (COL)	No cost	
Soil-retardant treatment	+\$ 28	Specify with soil-retardant treatment.
Sewn upholstery		
• Sewn upholstery on chair	+\$ 45	Add suffix S to the style number.
Base		
• Polished aluminum base	+\$167	Specify with polished aluminum base.
Arms		
• Height-adjustable arms, soft arm caps	-\$100	Specify with height-adjustable arms.
• Armless	-\$232	Specify without arms.

► Options, continued on next page

► Options, continued from previous page

Options	U.S. Price	Required to Specify
Seat Height		
• 4" pneumatic seat-height adjustment	+\$65	Specify with 4" pneumatic seat-height adjustment.
• 7" pneumatic seat-height adjustment	+\$65	Specify with 7" pneumatic seat-height adjustment.
Casters		
• Soft, dark grey treaded, dual-wheel roll-control casters for use on hard floors	+\$28	Specify with soft roll-control casters.
• Hard, polished aluminum casters on polished aluminum base for use on soft floors	+\$66	Specify with hard polished aluminum casters.
• Soft, polished aluminum casters on polished aluminum base for use on hard floors	+\$93	Specify with soft polished aluminum casters.
Glides		
• Glides: plastic	+\$28	Specify with glides.

Specification Information

Style Number	U.S. Base Price
4821412	\$1007



 **For Canadian Pricing**
Multiply U.S. Price by the Canadian price factor.
► See page 1 for details.

Amia 482 Series Stool

Upholstery on Seat and Back

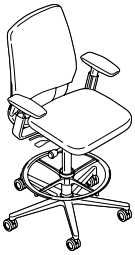

Tip: Frame packages include outer back shell, outer back frame, arm holsters, outer seat shell, and base.

*Tip: Suffixes other than **K** for contrasting fabric, will be added in alphabetical order when specifying options. The contrasting fabric suffix, **K**, will always be at the end of the style number.*

Tip: Leather and vinyl upcharges are in addition to sewn upholstery upcharge.

Standard Includes	Required to Specify
<ul style="list-style-type: none"> ▶ Need help? Product details, page 126 • Frame package color scheme: black • Synchro-tilt mechanism • 8" pneumatic seat-height adjustment • Upright back lock • Passive seat edge angle • Rectilinear independent height-, width-, pivot-, and depth-adjustable arms and soft arm caps: black plastic • 3" seat depth adjustment • Column and 4" adjustable foot ring: black • Standard upholstery design: fabric price group 1 • 2"-diameter, hard-composition, dual-wheel casters: black • Adjustable lumbar 	<ol style="list-style-type: none"> 1 Style number 2 Frame package color scheme (see below under Required Selections) 3 Fabric color number for upholstery on seat and back 4 Options, if selected (see below) <ul style="list-style-type: none"> ▶ See <i>Surface Materials</i>, page 676.

Required Selections	U.S. Price	Required to Specify
Frame Package Color Scheme <ul style="list-style-type: none"> • Black • Merle • Platinum • Seagull 	No cost +\$ 50 +\$ 50 +\$ 50	Specify with 6205 Black. Specify with 6527 Merle. Specify with 6249 Platinum. Specify with 6053 Seagull.

Options	U.S. Price	Required to Specify
Surface Materials		
Upholstery on seat and back <ul style="list-style-type: none"> • Fabric price group 1 • Fabric price group 2 • Fabric price group 3 • Fabric price group 4 • Fabric price group 5 • Fabric price group 6 • Fabric price group 7 • Fabric price group 8 • Fabric price group 9 • Fabric price group 10 • Steelcase leather upholstery • Select Surfaces leather price group 1 • Elmosoft leather upholstery • Select Surfaces leather price group 2 • Steelcase vinyl • Customer's Own Material (COM) • Customer's Own Leather (COL) 	No cost +\$ 29 +\$ 53 +\$ 75 +\$ 95 +\$116 +\$135 +\$169 +\$208 +\$235 +\$312 +\$312 +\$372 +\$372 +\$ 28 No cost No cost	Specify fabric color number. Specify fabric color number. Specify fabric color number. Specify fabric color number. Specify fabric color number. Specify fabric color number. Specify fabric color number. Specify fabric color number. Specify fabric color number. Specify fabric color number. Add suffix S to the style number and specify leather color number. Add suffix S to the style number and specify Select Surfaces leather price group 1. ▶ See <i>Surface Materials Reference Manual</i> . Add suffix S to the style number and specify Elmosoft leather color number. Add suffix S to the style number and specify Select Surfaces leather price group 2. ▶ See <i>Surface Materials Reference Manual</i> . Add suffix S to the style number and specify vinyl color number. ▶ See <i>Surface Materials Reference Manual</i> to specify. Add suffix S to the style number and specify leather color number.
Sewn upholstery <ul style="list-style-type: none"> • Sewn upholstery on chair 	+\$ 87	Add suffix S to the style number.
Contrasting upholstery on seat and back <ul style="list-style-type: none"> • Contrasting fabrics 	+\$ 34	Add suffix K to the style number and specify fabric color numbers.

▶ Options, continued on next page

▶ Detailed dimensions, page 132



For Canadian Pricing

Multiply U.S. Price by the Canadian price factor.

▶ See page 1 for details.

► Options, continued from previous page

Options	U.S. Price	Required to Specify
Surface Materials, continued		
Contrasting upholstery on seat		
• Fabric price group 1	No cost	Specify fabric color number.
• Fabric price group 2	+\$ 15	Specify fabric color number.
• Fabric price group 3	+\$ 26	Specify fabric color number.
• Fabric price group 4	+\$ 36	Specify fabric color number.
• Fabric price group 5	+\$ 48	Specify fabric color number.
• Fabric price group 6	+\$ 58	Specify fabric color number.
• Fabric price group 7	+\$ 68	Specify fabric color number.
• Fabric price group 8	+\$ 84	Specify fabric color number.
• Fabric price group 9	+\$104	Specify fabric color number.
• Fabric price group 10	+\$116	Specify fabric color number.
• Steelcase leather upholstery	+\$156	Add suffix S to the style number and specify leather color number.
• Select Surfaces leather price group 1	+\$156	Add suffix S to the style number and specify leather color number.
• Elmosoft leather upholstery	+\$186	Add suffix S to the style number and specify leather color number.
• Select Surfaces leather price group 2	+\$186	Add suffix S to the style number and specify leather color number.
• Customer's Own Material (COM)	No cost	► See <i>Surface Materials Reference Manual</i>
Contrasting upholstery on back		
• Fabric price group 1	No cost	Specify fabric color number.
• Fabric price group 2	+\$ 15	Specify fabric color number.
• Fabric price group 3	+\$ 26	Specify fabric color number.
• Fabric price group 4	+\$ 37	Specify fabric color number.
• Fabric price group 5	+\$ 48	Specify fabric color number.
• Fabric price group 6	+\$ 59	Specify fabric color number.
• Fabric price group 7	+\$ 68	Specify fabric color number.
• Fabric price group 8	+\$ 85	Specify fabric color number.
• Fabric price group 9	+\$104	Specify fabric color number.
• Fabric price group 10	+\$117	Specify fabric color number.
• Steelcase leather upholstery	+\$157	Add suffix S to the style number and specify leather color number.
• Select Surfaces leather price group 1	+\$157	Add suffix S to the style number and specify leather color number.
• Elmosoft leather upholstery	+\$186	Add suffix S to the style number and specify leather color number.
• Select Surfaces leather price group 2	+\$186	Add suffix S to the style number and specify leather color number.
• Customer's Own Material (COM)	No cost	► See <i>Surface Materials Reference Manual</i>
Soil-retardant treatment	+\$ 28	Specify <i>with soil-retardant treatment</i> .
Fire Code Seating (FCS)	+\$ 87	Add suffix F to the style number.
Fully upholstered		
• Fully upholstered with fabric	+\$146	Add suffix U to the style number.
• Fully upholstered with leather	+\$233	Add suffix SU to the style number.
• Steelcase leather fully upholstered outer back	+\$511	Add suffix SU to the style number and specify leather color number.
• Select Surfaces leather price group 1 fully upholstered outer back	+\$511	Add suffix SU to the style number and specify Select Surfaces leather price group 1.
• Elmosoft leather fully upholstered outer back	+\$601	► See <i>Surface Materials Reference Manual</i>
• Select Surfaces leather price group 2 fully upholstered outer back	+\$601	Add suffix SU to the style number and specify Elmosoft leather color number.
• Customer's Own Leather (COL) fully upholstered outer back	No cost	Add suffix SU to the style number and specify Select Surfaces leather price group 2.
		► See <i>Surface Materials Reference Manual</i>
		Add suffix SU to the style number.
		► See <i>Surface Materials Reference Manual</i>

Tip: Suffixes other than **K** for contrasting fabric, will be added in alphabetical order when specifying options. The contrasting fabric suffix, **K**, will always be at the end of the style number.

Tip: Leather and vinyl upcharges are in addition to sewn upholstery upcharge.

Tip: Fire Code Seating (FCS) option is available with certain upholstery fabric choices only.
► Page 696

Tip: Fire Code Seating (FCS) option is available on Amia chairs with fully adjustable arms or armless models only.

Tip: To get leather on a fully upholstered chair, you will need to add both the fully upholstered with leather upcharge and the upcharge for the leather itself.

► Options, continued on next page

**For Canadian Pricing**

Multiply U.S. Price by the Canadian price factor.

► See page 1 for details.

Amia 482 Series Stool, Upholstery on Seat and Back, continued

► Options, continued from previous page

Options	U.S. Price	Required to Specify	
Arms	• Height-adjustable arms, soft arm caps • Armless	-\$100 -\$232	Specify <i>with height-adjustable arms</i> . Specify <i>without arms</i> .
Casters	• Soft, dark grey treaded, dual-wheel roll-control casters for use on hard floors	+\$ 28	Specify <i>with soft roll-control casters</i> .
Glides	• Glides: plastic	+\$ 28	Specify <i>with glides</i> .

Specification Information

Style Number	U.S. Base Price
4827410	\$1402
:	:



 **For Canadian Pricing**
 Multiply U.S. Price by the Canadian price factor.
 ► See page 1 for details.

Amia 482 Series Stool

3D Knit on Back with Upholstery on Seat



Tip: Frame packages include outer back shell, outer back frame, arm holsters, outer seat shell, and base.

Tip: Always add suffixes in alphabetical order when specifying options to Amia seating.

Tip: Leather and vinyl upcharges are in addition to sewn upholstery upcharge.

► Detailed dimensions, page 132

Tip: Fire Code Seating (FCS) option is available with certain upholstery fabric choices only.

► Page 696

Tip: Fire Code Seating (FCS) option is available on Amia chairs with fully adjustable arms only or armless models only.

Standard Includes		Required to Specify
► Need help? Product details, page 126	<ul style="list-style-type: none"> Frame package color scheme: black Synchro-tilt mechanism 8" pneumatic seat-height adjustment Upright back lock Passive seat edge angle Rectilinear independent height-, width-, pivot-, and depth-adjustable arms and soft arm caps: black plastic 3" seat depth adjustment Column and 4" adjustable foot ring: black 3D Knit on back only Standard upholstery design on seat: fabric price group 1 2"-diameter, hard-composition, dual-wheel casters: black Adjustable lumbar 	<ol style="list-style-type: none"> Style number Frame package color scheme (see below under Required Selections) 3D Knit color for back Fabric color number for upholstery on seat Options, if selected (see below) <p>► See <i>Surface Materials</i>, page 676.</p>

Required Selections	U.S. Price	Required to Specify	
Frame Package Color Scheme	<ul style="list-style-type: none"> Black Merle Platinum Seagull 	<ul style="list-style-type: none"> No cost +\$ 50 +\$ 50 +\$ 50 	<ul style="list-style-type: none"> Specify with 6205 Black. Specify with 6527 Merle. Specify with 6249 Platinum. Specify with 6053 Seagull.

Options	U.S. Price	Required to Specify	
Surface Materials			
Upholstery			
<ul style="list-style-type: none"> Fabric price group 1 Fabric price group 2 Fabric price group 3 Fabric price group 4 Fabric price group 5 Fabric price group 6 Fabric price group 7 Fabric price group 8 Fabric price group 9 Fabric price group 10 Steelcase leather upholstery 	<ul style="list-style-type: none"> No cost +\$ 15 +\$ 26 +\$ 36 +\$ 48 +\$ 58 +\$ 68 +\$ 84 +\$104 +\$116 +\$156 	<ul style="list-style-type: none"> Specify fabric color number. Specify fabric color number. Specify fabric color number. Specify fabric color number. Specify fabric color number. Specify fabric color number. Specify fabric color number. Specify fabric color number. Specify fabric color number. Specify fabric color number. Specify fabric color number. Add suffix S to the style number and specify leather color number. Add suffix S to the style number and specify Select Surfaces leather price group 1. 	
<ul style="list-style-type: none"> Select Surfaces leather price group 1 Elmosoft leather upholstery Select Surfaces leather price group 2 Steelcase vinyl Customer's Own Material (COM) Customer's Own Leather (COL) 	<ul style="list-style-type: none"> +\$156 +\$186 +\$186 +\$ 15 No cost No cost 	<ul style="list-style-type: none"> ► See <i>Surface Materials Reference Manual</i>. Add suffix S to the style number and specify Elmosoft leather color number. Add suffix S to the style number and specify Select Surfaces leather price group 2. ► See <i>Surface Materials Reference Manual</i>. Add suffix S to the style number and specify vinyl color number. ► See <i>Surface Materials Reference Manual</i> to specify. Add suffix S to the style number and specify leather color number. 	
Soil-retardant treatment	+\$ 28	Specify with soil-retardant treatment.	
Fire Code Seating (FCS)	+\$ 87	Add suffix F to the style number.	
Sewn upholstery			
<ul style="list-style-type: none"> Sewn upholstery on chair 	<ul style="list-style-type: none"> +\$ 45 	<ul style="list-style-type: none"> Add suffix S to the style number. 	
Arms	<ul style="list-style-type: none"> Height-adjustable arms, soft arm caps Armless 	<ul style="list-style-type: none"> -\$100 -\$232 	<ul style="list-style-type: none"> Specify with height-adjustable arms. Specify without arms.

► Options, continued on next page

► Options, continued from previous page

Options	U.S. Price	Required to Specify
Casters • Soft, dark grey treaded, dual-wheel roll-control casters for use on hard floors	+\$28	Specify <i>with soft roll-control casters</i> .
Glides • Glides: plastic	+\$28	Specify <i>with glides</i> .

Specification Information

• Style • Number • •	• U.S. • Base • Price •
4827418	\$1468
•	•



For Canadian Pricing
 Multiply U.S. Price by the Canadian price factor.
 ► See page 1 for details.

Amia 482 Series Stool

Air Back with 3D Microknit and Upholstery on Seat



Tip: Amia Air frame packages include inner back frame and lumbar, outer back frame, arm holsters, outer seat shell, and base.

Tip: To specify a non-contrasting seat back, the air back plastic color finish and 3D Microknit color finish must be the same.

Tip: Leather and vinyl upcharges are in addition to sewn upholstery upcharge.

► Detailed dimensions, page 132



For Canadian Pricing

Multiply U.S. Price by the Canadian price factor.

► See page 1 for details.

Standard Includes		Required to Specify
► Need help? Product details, page 126	<ul style="list-style-type: none"> • Frame package color scheme: black • Synchro-tilt mechanism • 8" pneumatic seat-height adjustment • Upright back lock • Passive seat edge angle • Rectilinear independent height-, width-, pivot-, and depth-adjustable arms and soft arm caps: black plastic • 3" seat depth adjustment • Column and 4" adjustable foot ring: black • Air back with integrated Air LiveBack technology: plastic price groups 1 and 2 • Standard upholstery design on seat: fabric price group 1 • 2"-diameter, hard-composition, dual-wheel casters: black 	<ol style="list-style-type: none"> 1 Style number 2 Frame package color scheme (see below under Required Selections) 3 Fabric color number for upholstery on seat 4 Air back plastic color number 5 3D Microknit color number for back 6 Options, if selected (see below) <p>► See <i>Surface Materials</i>, page 676.</p>

Required Selections	U.S. Price	Required to Specify
Frame Package Color Scheme	<ul style="list-style-type: none"> • Black No cost • Merle +\$ 50 • Platinum +\$ 50 • Seagull +\$ 50 	Specify with 6205 Black. Specify with 6527 Merle. Specify with 6249 Platinum. Specify with 6053 Seagull.

Options	U.S. Price	Required to Specify
Surface Materials		
Upholstery		
• Fabric price group 1	No cost	Specify fabric color number.
• Fabric price group 2	+\$ 15	Specify fabric color number.
• Fabric price group 3	+\$ 26	Specify fabric color number.
• Fabric price group 4	+\$ 36	Specify fabric color number.
• Fabric price group 5	+\$ 48	Specify fabric color number.
• Fabric price group 6	+\$ 58	Specify fabric color number.
• Fabric price group 7	+\$ 68	Specify fabric color number.
• Fabric price group 8	+\$ 84	Specify fabric color number.
• Fabric price group 9	+\$104	Specify fabric color number.
• Fabric price group 10	+\$116	Specify fabric color number.
• Steelcase leather upholstery	+\$156	Specify fabric color number. Add suffix S to the style number and specify leather color number.
• Select Surfaces leather price group 1	+\$156	Specify fabric color number. Add suffix S to the style number and specify Select Surfaces leather price group 1.
• Elmosoft leather upholstery	+\$186	Specify fabric color number. Add suffix S to the style number and specify Elmosoft leather color number.
• Select Surfaces leather price group 2	+\$186	Specify fabric color number. Add suffix S to the style number and specify Select Surfaces leather price group 2.
• Steelcase vinyl	+\$ 15	Specify fabric color number. Add suffix S to the style number and specify vinyl color number.
• Customer's Own Material (COM)	No cost	Specify fabric color number. Add suffix S to the style number and specify vinyl color number.
• Customer's Own Leather (COL)	No cost	Specify fabric color number. Add suffix S to the style number and specify leather color number.
• Customer's Own Material/Vinyl (COM-Sewn)	No cost	Specify fabric color number. Add suffix S to the style number and specify vinyl color number.
Soil-retardant treatment	+\$ 28	Specify with soil-retardant treatment.
Sewn upholstery		
• Sewn upholstery on chair	+\$ 45	Add suffix S to the style number.
Arms		
• Height-adjustable arms, soft arm caps	-\$100	Specify with height-adjustable arms.
• Armless	-\$232	Specify without arms.
Casters		
• Soft, dark grey treaded, dual-wheel roll-control casters for use on hard floors	+\$ 28	Specify with soft roll-control casters.
Glides		
• Glides: plastic	+\$ 28	Specify with glides.

Specification Information

• Style • Number	• U.S. • Base • Price
4827414	\$1287



For Canadian Pricing
Multiply U.S. Price by the
Canadian price factor.
▶ See page 1 for details.

Amia 482 Series Stool

Air Back with Upholstery on Seat



Tip: Amia Air frame packages include inner back frame and lumbar, outer back frame, arm holsters, outer seat shell, and base.

Tip: When merle, platinum, or seagull are selected as frame packages, the outer seat shell and inner back frame default to 6527 Merle plastic.

Tip: Leather and vinyl upcharges are in addition to sewn upholstery upcharge.

► Detailed dimensions, page 132



For Canadian Pricing
Multiply U.S. Price by the Canadian price factor.

► See page 1 for details.

Standard Includes		Required to Specify
► Need help? Product details, page 126	<ul style="list-style-type: none"> Frame package color scheme: black Synchro-tilt mechanism 8" pneumatic seat-height adjustment Upright back lock Passive seat edge angle Rectilinear independent height-, width-, pivot-, and depth-adjustable arms and soft arm caps: black plastic 3" seat depth adjustment Column and 4" adjustable foot ring: black Air back with integrated Air LiveBack technology: plastic price groups 1 and 2 Standard upholstery design on seat: fabric price group 1 2"-diameter, hard-composition, dual-wheel casters: black 	<ol style="list-style-type: none"> Style number Frame package color scheme (see below under Required Selections) Fabric color number for upholstery on seat Air back plastic color number Options, if selected (see below) <p>► See <i>Surface Materials</i>, page 676.</p>

Required Selections	U.S. Price	Required to Specify
Frame Package Color Scheme	<ul style="list-style-type: none"> Black: No cost Merle: +\$ 50 Platinum: +\$ 50 Seagull: +\$ 50 	<p>Specify with 6205 Black.</p> <p>Specify with 6527 Merle.</p> <p>Specify with 6249 Platinum.</p> <p>Specify with 6053 Seagull.</p>

Options	U.S. Price	Required to Specify
Surface Materials		
Upholstery	<ul style="list-style-type: none"> Fabric price group 1: No cost Fabric price group 2: +\$ 15 Fabric price group 3: +\$ 26 Fabric price group 4: +\$ 36 Fabric price group 5: +\$ 48 Fabric price group 6: +\$ 58 Fabric price group 7: +\$ 68 Fabric price group 8: +\$ 84 Fabric price group 9: +\$104 Fabric price group 10: +\$116 Steelcase leather upholstery: +\$156 Select Surfaces leather price group 1: +\$156 Elmosoft leather upholstery: +\$186 Select Surfaces leather price group 2: +\$186 Steelcase vinyl: +\$ 15 Customer's Own Material (COM): No cost Customer's Own Leather (COL): No cost 	<p>Specify fabric color number.</p> <p>Specify fabric color number.</p> <p>Specify fabric color number.</p> <p>Specify fabric color number.</p> <p>Specify fabric color number.</p> <p>Specify fabric color number.</p> <p>Specify fabric color number.</p> <p>Specify fabric color number.</p> <p>Specify fabric color number.</p> <p>Specify fabric color number.</p> <p>Specify fabric color number.</p> <p>Add suffix S to the style number and specify leather color number.</p> <p>Add suffix S to the style number and specify Select Surfaces leather price group 1.</p> <p>► See <i>Surface Materials Reference Manual</i>. Add suffix S to the style number and specify Elmosoft leather color number.</p> <p>Add suffix S to the style number and specify Select Surfaces leather price group 2.</p> <p>► See <i>Surface Materials Reference Manual</i>. Add suffix S to the style number and specify vinyl color number.</p> <p>► See <i>Surface Materials Reference Manual</i> to specify.</p> <p>Add suffix S to the style number and specify leather color number.</p> <p>Specify with soil-retardant treatment.</p>
Soil-retardant treatment	+\$ 28	
Sewn upholstery		
• Sewn upholstery on chair	+\$ 45	Add suffix S to the style number.

Arms	<ul style="list-style-type: none"> Height-adjustable arms, soft arm caps: -\$100 Armless: -\$232 	Specify with height-adjustable arms. Specify without arms.
-------------	--	--

Casters	• Soft, dark grey treaded, dual-wheel roll-control casters for use on hard floors	+\$ 28	Specify with soft roll-control casters.
----------------	---	--------	---

Glides	• Glides: plastic	+\$ 28	Specify with glides.
---------------	-------------------	--------	----------------------

Specification Information

• Style • Number	• U.S. • Base • Price
4827412	\$1228



For Canadian Pricing
Multiply U.S. Price by the
Canadian price factor.
▶ See page 1 for details.

